

AUTEL VEHICLE DIAGNOSTIC TOOLS

Autel MaxiSys MS906, 906TS, MaxiSysPro, MaxiSys Elite



Automotive Diagnostic & Analysis Systems	MaxiSYS PRO/ 906TS #AUL-MS906 / 906TS	MaxiSYS 908/908 PRO #AUL-MS908/908PRO	MaxiSYS Elite #AUL-MD808
CPU & Memory	Samsung Exynos 6-Core 32GB	Samsung Exynos A9 Quad-Core 1.4GHz, 32GB	NVIDIA Tegra 4 Quad-Core 1.8Ghz, 32GB
Touch Screen	8" 1024*768 LED	9.7" 1024*769 LED	9.7" 2048*1536 Retina LCD
Connectivity	USB2/Wi-Fi/Bluetooth for 906TS	USB2/Wi-Fi/Bluetooth	USB2/Wi-Fi/Bluetooth
Internal Battery	•	•	•
Camera (Rear)	8 Megapixel/AF/Flash	5 Megapixel/AF/Flash	8 Megapixel/AF/Flash
Wireless Bluetooth VCI	optional	(uses J2534 for 908 Pro)	(uses J2534)
Optional Lab Scope and/or Optional Video-Scope	•	•	•
OEM-Level Coverage for Domestic, Asian & Euro	•	•	•
Auto VIN Technology	•	•	•
MaxiFix Cloud-Based Information System	•	•	•
ECU Coding	•	Advanced	Advanced
ECU Flash Programming	Optional with MaxiFlash Kit	•	2x faster
Printing of Recorded Data	•	•	•
1996-2001 Connector kit	Complete Connector Kit	Complete Connector Kit	Complete Connector Kit
J2534 Hardware	Optional	Optional / Included	•
Software Updates	1 Year Free	1 Year Free	1 Year Free
Price	\$1795/ \$2395	\$2595/\$3495	\$3995

MaxiTPMS TS508

Tire Pressure Sensor Diagnostic Tool

Tool with 8 Programmable MX-Sensors

- Activate & Relearn All Known Sensors
- Read Sensor ID, Temperature & Pressure
- Read Battery Power Level Condition
- Sensor Position Relearn
- 4 Sensor Programming Options
- Copy by Activation/Manual Input/OBD
- Auto Create 1-16 Sensors
- Read & Clear DTCs from ECU



MaxiTPMS TS608

Besides all functions of TS508, TS608
Also includes All systems Diagnostics

- Read/Clear codes for all available electronic systems
- Turn off warning lights;
- Display live data in text, graph & analog for easy data review
- Supports all 10 test modes of the latest J1979 OBD II test specs
- Enhanced OBD II Mode 6.
- One year free update on the internet.



Programmable TPMS Sensors with Interchangeable Rubber Valve Stems

- 100% ID cloneable, no relearn required



Part#	Description	Price
AUL-MXSENSOR315R	315MHz Sensor with Rubber Stem	\$45
AUL-MXSENSOR433R	433 MHz Sensor with Rubber Stem	\$45

MaxiDiag MD808

- One tool can do it all-Reads and clear trouble codes on either the basic 4 systems (engine, transmission, ABS and airbag) or all the systems
- Support EPB, SAS & Oil Reset Service
- Turn off warning lights
- Supports all 10 test modes of latest J1979 OBD II test specs, including Read Codes, Erase Codes, Live Data, Freeze Frame I/M Readiness, O2 Monitoring Test, On-Board Mon. Test
- Component Test and Vehicle Information



- Enhanced OBD II Mode 6
- OBD II code tips guide technicians to the root cause of trouble code faster
- Data graphing
- Includes all European, Asian & Domestic Vehicle Coverage
- Free Software Upgrade

Prices are subject to change without notice.

Scan This QR Code With Your Smart Phone To Visit Our Website



PROTEC

P: 1844-PROTEC9 (1844-776-8329)
or 905-569-8878

For more information, please visit our website:
www.protecequipment.ca

LAUNCH VEHICLE DIAGNOSTIC TOOLS

**X431 Pro
\$1795**



ScanPad X431 Pro and Pro 3 Android Scan Tool Tablet

The ScanPad X431 Pro and Pro 3 is a robust, drop-tested Android based scan tool with an 8 inch and 10.1 inch High Resolution Capacitive Touch Screen.

- Featuring an open Android™ operating system for a true table experience – install third party apps and software!
- Class-1 Bluetooth 4.0 Connector for optimum wireless connectivity
- Launch next generation software suite: OE-Level access to Asian, European and Domestic applications for module coding, resets, relearns & bidirectional capabilities
- Built-in customer management software and link to LAUNCH online user community
- Auto-ID all available vehicle systems and modules
- One-Click Wi-Fi software updates
- One Year Warranty and One Year Free update

X431 Pro **\$1795** X431 Pro 3 **\$2595**

Includes 1 Year warranty and 1 year free update

X431 PAD II A (Enhanced) Android Scan Tool Tablet

The PADII A is a robust, drop-tested and waterproof Android based scan tool tablet with a 10.1 inch ultra-high resolution IPS touch screen.

- Features vast vehicle coverage, powerful special test functions, ultra-fast live data and graphing, along with module-coding capabilities.
- New revolutionary Customer Remote Diagnostics capability called “Golo” that allows the shop owner and technician to remotely analyze customer vehicle data outside the shop, even thousands of miles away!
- A built-in customer management system and online user community link further extends the utility and efficiency of the PADII.

“Includes Golo Care”



\$3350

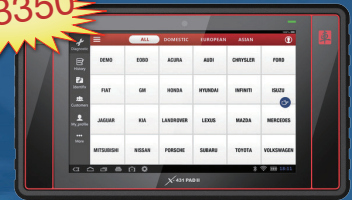

X431 PADII A

Includes 1 Year warranty and 1 year free update

CRReader Pro 229

- Android Based, 5 inch high resolution touch screen
- WiFi enabled for Web Browsing
- Graph multiple PIDs of Live data
- Access All Vehicle Systems for Reading and Clearing Codes & Live Data
- Performs The Following:
Oil Light Resets, Electronic Parking Brake (Retract Reset), Steering Angle Reset, Battery Registration
- GOLO ready! Remove diagnostics and telematics with optional GOLO connector



\$799

CRP123 Premium / CRP129 Premium

The CRP123 Premium contains:

- Enhanced manufacturer specific Domestic, Asian & European coverage for technicians to diagnose Engine, Transmission, ABS and Airbag (SRS) systems.
- In addition, the CRP129 also includes Electronic Parking Brake (EPB) release
- Steering Angle Sensor (SAS) and Oil Service Light resets. Graph, Record and Play Back crucial data to more efficiently diagnose driveability issues.
- View Engine, ABS, SRS along with A/T enhanced data.
- Includes 1 Year warranty.



**CRP123 Premium
\$399**

CRP123 Premium **\$399**
CRP129 Premium **\$549**

Millennium 90

Multi-purpose code reader provides 10 OBDII / EOBD diagnostic modes, Plus oil reset, brake bleeding, EPB, BMS, DPF and SAS reset, Live data stream reading, ABS and SRS diagnosis



\$299

TSAP-1 Tire Sensor Activation / Programming tool

- Check Tire Pressures in seconds
- Displays all available sensor data (ID, PSI, MHz, Tire Temp, Battery Life)
- One tool programs most aftermarket universal sensors
- Intuitive step-by-step instructions for sensor programming
- Provides vehicle selection via MMY look-up
- Replacement TPM sensor part number look-up
- Can be used in conjunction with scan tools
- 2 year Software updates and 2 year warranty



\$699

FCAR HEAVY DUTY AND PASSENGER VEHICLE DIAGNOSTIC TOOLS

FCAR F7S-G Heavy Duty Trucks and All Passenger Vehicles

FCAR F7S-G is an all-in-one wireless tablet scanner designed to be ONE tool that any service professional will need, from car, truck or HD equipment.

- 10.1" HD Android tablet, Quad-core 1.2Ghz Processor, built-in WiFi and Bluetooth
- Online technical information and wiring diagram.
- OE Level scanner coverage including both diesel and gasoline vehicle (12V-24V)
- Design to connect all kinds of vehicle sockets.
- All-in-one automotive diagnostic system covering passenger & light commercial vehicles, heavy duty trucks and off-road equipment.
- VIN Automatic detection for passenger vehicles.
- Read DTC, Clear DTC, Engine Models, ECU information, System Parameter Number, Data Stream, Cylinder Test, Compression Test, Bi-Directional Injector Test, Actuation Test, Key Programming, Service Reset, Adaptations, Maintenance Help, DPF Regeneration, etc.



One year warranty & Two Years Free Update!

FCAR F5-G Heavy Duty Trucks and All Passenger Vehicles scanner also available (Printer is Optional)



One Year Warranty & Two Years Free Update!



F3S-N

One Year Warranty & Two Years Free Update!

FCAR F3S-N Heavy Duty Trucks and American Vehicles

FCAR F3S-N Truck Pro is professional diagnostic scan tool for North American Heavy duty, super duty and light duty trucks. It has covered most heavy duty on-highway trucks and off-highway utility vehicles for testing most electronic, engine, transmission ABS and Airbag modules with bi-directional functions. Scanner Coverage:

- HD Diesel Engines Cummins, Detroit, Caterpillar and more.
- Domestic HD Trucks: Caterpillar, Freightliner, International, Kenworth, Peterbilt, Serling, LaFrance, Autocar, Pierce, Bobcat, John Deere.
- Imported HD Trucks: Fuso, Hino, Isuzu, Volvo, Mack, Mercedes, Man, Iveco.
- Super Duty and Light Duty Trucks or Gasoline Pickup: Ford F Series, Dodge RAM, GMC, Chevrolet Silverado, Spinter, Suburban etc...
- Extra coverage: all Ford, GM, Chrysler, Dodge passenger vehicles.
- Including connectors: OBD 16, Diesel 6, Diesel 9 (Cummins 9 pin), CAT 9.



One Year Warranty & Two Years Free Update!

FCAR F6 Plus Passenger and Light Commercial Vehicles

F6 Plus, Android based all-in-one smart diagnostic tool for all European, Asian and American Cars with bi-directional capabilities.

- 8" IP67 Android tablet, water and oil proof, built-in WiFi & Bluetooth.
- Automatically identify vehicles and systems.
- One key update/recognition/feedback/Remote support.
- Basic functions: read/clear DTCs, read live data and actuation Test.
- Special functions: ABS exhaust, DPF, ECU reset, EPB, lamp adaption, SAS, service reset, smart key program, SRS reset, suspension, throttle reset, TPMS, injector and cylinder test, etc.
- Diagram wiring, technical information, diagnostic solutions & maintenance services.



Includes 1 Year Warranty & Free Update.

FCAR F506 Heavy Duty Code Reader

F506 is a Professional Heavy Duty Code Reader with Extensive International, Hino, Isuzu & UD trucks Coverage and Generic OBD II

- Works with all 1996 and newer vehicles (OBDII and CAN) and standard protocols of heavy duty Trucks (J1939 and J1708)
- More coverage, also covers Hino, Mitsubishi Fuso, Isuzu and UD commercial vehicles.
- Access Engine, Transmission, ABS, Brakes, Instrument clusters.
- Read and clear diagnostic trouble codes and view live data.
- Includes OBD 16 and Diesel 6 and 9 pin connectors.
- Provides on screen DTC definitions for heavy-duty standard codes.

A/C MACHINE, TRANSMISSION FLUID CHANGER, SMOKE MACHINE & BATTERY TESTER

A/C-400 Fully Automatic A/C Service Station for R134yf Refrigerant

- Automatic Recovery/Vacuum Oil Injection /Recharge
- Comprehensive Vehicle A/C Capacity Database
- Automatic Protection Program and Audible Alarms
- LCD Screen & Built in Thermal Printer



AC-400
\$2995

AC-400



AC-600
\$3995

A/C-600 Fully Automatic A/C Service Station for HFO1234yf Refrigerant

- Automatic Recovery/Vacuum Oil Injection /Recharge
- Comprehensive Vehicle A/C Capacity Database
- Automatic Protection Program and Audible Alarms
- LCD Screen & Built in Thermal Printer
- A/C-600 Powerful Vacuum Pump & Ventilation System (do not require spark to start, more safety)

AC-600

Also available:

- A/C-500 for Truck R134A Refrigerant with UV Dye Leak Detection Kit and Flush Function **\$3495**
- A/C-800 for Coach/Bus R134A Refrigerant with 30L Large Tank and Vacuum Leak Test **\$4995**

ATF-102
\$1995



ATF-102 Fully Automatic Transmission Fluid Changer

- Auto Fluid Exchange
- Fluid Level Adjustment
- Automatic Discharging of Used Fluid
- Auto Fluid Flow Direction Sensor
- Transmission System Cleaning

ATF-102

X-SonicClean BT Injector Diagnostics and Cleaner

- Spray Pattern Testing & Evaluation
- Injector Flow & Volume Test
- Ultrasonic Cleaning & Auto Test
- Injector Leak Down Test
- Injector "Reverse Flush" Cleaning



\$1495

ALL-300 Car Smoke Machine ALL-300HD Truck Smoke Machine

- EVAP Leak Test
- Exhaust Leak Test
- Under Dash Test
- Manifold Leak Test
- Vacuum Leak Test
- Built in Air Compressor
- Smoke Works with mineral oil (baby oil)
- Includes 1 Year Warranty
- All-300HD Works for Heavy Duty Trucks



\$849

ALL-300



\$1495

ALL-300HD

\$349



BAT PLUS Battery Tester

- Battery Test
- Grounding Test
- Starter Test
- Alternator Test
- Test all 12 Volt Batteries
- Compatible with CCA, SAE, DIN, JIS, IEC, EN and CA
- Includes 1 Year Warranty, Built In Thermal Printer.

TOOLS CABINET, WASTE OIL DRAINER AND HIGH TRANSMISSION JACK



TB-C310
Tool Cabinet



TB-C600
5 Drawers Tool Cabinet



TB-C700
7 Drawers Tool Cabinet

Model	TB-C310	TB-C600	TB-C700
New weight	11KG (24LB)	60KG (132LB)	64KG (141LB)
Gross weight	12KG (26Lb)	62.5KG (138Lb)	66.5KG (147Lb)
Package Size	78cm*66cm*35cm	88cm*83cm*52cm	88cm*83cm*52cm
Product Size	31 "H*26"L*14"W	35 "H*32"L*20"W	35"H*32"L*20"W

HC-2085 and HC-2285 Oil Drainer & Extractor Specifications:

Tank Capacity (Liter/US Gallon)	3 137/171	3 167/211
Air Inlet pressure (Bar/Psi)	6~8 / 87~116	6~8 / 87~116
Air Inlet connection (Inch)	1/4"	1/4"
Vacuum Degree (Bar)	-1~0	-1~0
Air pressure for oil discharge (Bar/Psi)	0.7~1/10~15	0.7~1/10~15
Oil Temperature range (°C)	40~60	40~60
Draining Hose (dia.@Length)	G1/2*1.5m	G1/2*2.0m
Connection Bowl Capacity (Liter/US Gallon)	3 17/21	3 17/21
Connection Bowl Diameter (mm)	400	400
Maximum Height (mm)	1650	1680
Minimum Height (mm)	1025	1040
Optional Extension Funnel Diameter (mm)	560	560
Gross Weight/Net weight (Kgs)	166/191	211/245
Dimension (mm)	470* 440* 940*	550* 430* 980*



HC-2085
Oil Drainer

HC-2285
Oil Drainer



TJ-90103
High Transmission Jack



TJ-90104
High Transmission Jack

TJ-90103 and TJ-90104 High Transmission Jack Specifications:

Model	TJ-90103	TJ-90104
Lifting weight	0.5 Tons/1102 lbs	0.5 Tons/1102 lbs
Min. height	870mm/34.3"	870mm/34.3"
Max. height	1800mm/70.9"	1750mm/68.9"
1st stage lift	465mm/18.3"	450mm/17.7"
2 nd stage lift	465mm/18.3"	450mm/17.7"
Net weight	80kg/176lbs	60kg/132lbs
Gross weight	86kg/189lbs	68kg/150lbs

TIRE CHANGERS

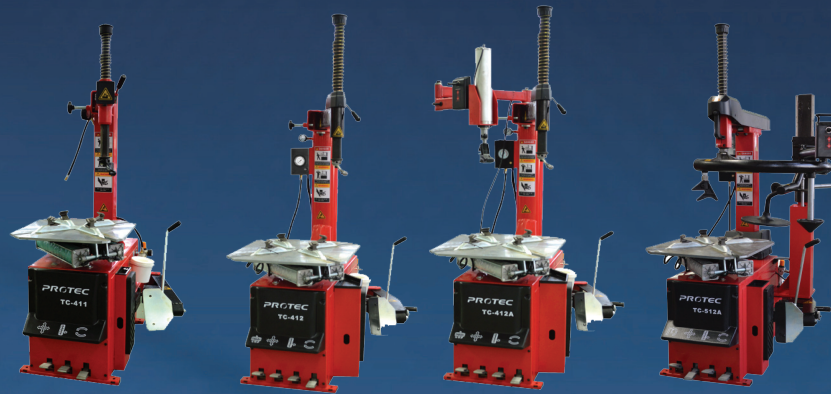

Tire Changers

Model #	TC-411	TC-412	TC-412A	TC-512A
Description	Swing arm tire changer without bead blaster	Swing arm tire changer with bead blaster	Swing arm tire changer with bead blaster and left assist arm assembly	Tilt back tire changer with bead blaster and right assist arm assembly
Power supply	110V/60Hz, single phase, 1HP Motor	110V/60Hz, single phase, 1.5HP Motor (CSA)	110V/60Hz, single phase, 1.5HP Motor (CSA)	110V/60Hz, single phase, 1.5HP Motor (CSA)
Air Supply	8-12bar (0.8-1.2Mpa)	8-12bar (0.8-1.2Mpa)	8-12bar (0.8-1.2Mpa)	8-12bar (0.8-1.2Mpa)
Rim Clamping (External)	10"-22"	12"-26"	12-26"	12"-26"
Rim Clamping (Internal)	12"-24"	14"-28"	14"-28"	14"-28"
Beed Braker Force	4000LB (2000KG)	5500LB (2500KG)	5500LB (2500KG)	5500LB (2500KG)
Max. Wheel diameter	37"(950mm)	43"(1100mm)	43"(1100mm)	43"(1100mm)
Max. Wheel width	13"(330mm)	15"(381mm)	15"(381mm)	15"(381mm)
Noise	<70dB	<70dB	<70dB	<70dB
N.W/G.W	424Lb/513Lb (193Kg/233Kg)	550Lb/675Lb (250Kg/307Kg)	585Lb/705Lb (265Kg/320kg)	685Lb/779Lb (299Kg/354kg)
Packing Size	980*760*970(mm)	1140*950*980(mm)	1140*950*980(mm)	980*760*980(mm)
Price	\$1695	\$1995	\$2395	\$2995

Combo Specials:



TC-411 + WB-511 \$3195
SAVE \$500



TC-412 + WB-511 \$3495
SAVE \$500



TC-412A + WB-511 \$3895
SAVE \$500



TC-512A + WB-511 \$4495
SAVE \$500

TIRE CHANGERS



Low Profile Tire Changers

Model #	TC-512B	TC-513A	TC-612A	TC-612B
Description	Tilt back tire changer with bead blaster and right assist arm assembly	Tilt back tire changer with bead blaster and right assist arm assembly	Swing arm tire changer with bead blaster and right assist arm assembly	Swing arm tire changer with bead blaster & dual assist arm assembly
Power supply	110V/60Hz, single phase, 1.5HP Motor (CSA)	110V/60Hz, single phase 1.5HP Motor	110V/60Hz, single phase, 1.5HP Motor (CSA approved)	110V/60Hz, single phase, 1.5HP Motor (CSA approved)
Air Supply	8-12bar (0.8-1.2Mpa)	8-12bar (0.8-1.2Mpa)	8-12bar (0.8-1.2Mpa)	8-12bar (0.8-1.2Mpa)
Rim Clamping (External)	12"-26"	12"-24"	12"-26"	12"-26"
Rim Clamping (Internal)	14"-28"	10"-21"	14"-28"	14"-28"
Beed braker force	5500LB (2500KG)	5500LB (2500KG)	5500LB (2500KG)	5500LB (2500KG)
Max. Wheel diameter	43"(1100mm)	39"(1000mm)	43"(1100mm)	43"(1100mm)
Max. Wheel width	15"(381mm)	14"(355mm)	13"(330mm)	15"(381mm)
Noise	<70dB	<70dB	<70dB	<70dB
N.W/G.W	685Lb/779Lb (299Kg/354kg)	607Lb/684Lb (276kg/311kg)	704Lb/825Lb (320kg/375kg)	704Lb/825Lb (320kg/375kg)
Packing Size	980*760*980(mm)	960*760*1050(mm)	1140*950*980(mm)	1140*950*980(mm)
Price	\$3195	\$3095	\$3095	\$3495

Combo Specials:



TC-513A + WB-611 \$4995
SAVE \$500



TC-512B + WB-514 \$5695
SAVE \$500



TC-612A + WB-611 \$4995
SAVE \$500



TC-612B + WB-514 \$5995
SAVE \$500

TIRE CHANGERS

New Model Tire Changers



Model #	TC-1291IT	TC-1298IT	TC-1227IT	TC-1297IT
Description	Tilt arm tire changer with bead blaster and left assist arm assembly	Swing arm tire changer with bead blaster and assist on both sides	Tilt arm tire changer with bead blaster and left assist arm assembly	Swing arm tire changer with bead blaster and left assist arm assembly
Power supply	110V/60Hz, single phase, 1.5 HP Motor	110V/60Hz, single phase, 1.5HP Motor	110V/60Hz, single phase, 1.5HP Motor	110V/60Hz, singlephase, 1.5HP Motor
Air Supply	8-10bar (116-145PSI)	8-10bar (116-145PSI)	8-10bar (116-145PSI)	8-10bar (116-145PSI)
Rim Clamping (External)	12"-23"	12"-26"	12"-24"	12-26"
Rim Clamping (Internal)	14"-26"	14"-28"	10"-21"	14"-28"
Max. Wheel diameter	45"(1143mm)	45"(1143mm)	41"(1040mm)	45"(1143mm)
Max. Wheel width	16"(406mm)	16"(406mm)	14"(355mm)	16"(406mm)
N.W/G.W	532Lb/594Lb (242Kg/270Kg)	559Lb/682Lb (254Kg/310kg)	660Lb/743Lb (310Kg/359Kg)	737Lb/856Lb (335Kg/389kg)
Packing Size	1130*900*1070(mm)	1130*900*1070(mm)	960*760*1070(mm)	900*1130*1070(mm)
Price	\$2395	\$2995	\$3495	\$3995

Combo Specials:



TC-1291IT + WB-1120 \$3995
SAVE \$500



TC-1298IT + WB-711 \$5195
SAVE \$500



TC-1227IT + WB-711 \$5695
SAVE \$500



TC-1297IT + WB-711 \$6195
SAVE \$500

LEVERLESS TIRE CHANGERS

Leverless Tire Changers



Model #	TC-712A	TC-1295	TC-1239
Description	Leverless tilt arm tire changer with bead blaster and left assist arm assembly	Leverless swing arm tire changer with left assist arm assembly and lifter	Leverless Tire changer with high resolution camera and 8" LCD Visualization system
Power supply	110V/60Hz, single phase, 1.5HP Motor	110V/60Hz, single phase, 1.5HP Motor	220V/60Hz, single phase, 2HP Motor
Air Supply	8-10bar (116-145PSI)	8-10bar (116-145PSI)	8-10bar (116-145PSI)
Rim Clamping (External)	12"-23"	8-28"	10"-30"
Rim Clamping (Internal)	14"-26"	8"-28"	10"-30"
Max. Wheel diameter	45"(1143mm)	45"(1143mm)	49"(1250mm)
Max. Wheel width	16"(406mm)	16"(406mm)	22"(558mm)
N.W/G.W	660Lb/743Lb (310Kg/350Kg)	715Lb/781Lb (320Kg/355Kg)	1261Lb/1452Lb (573Kg/660Kg)
Packing Size	1130*900*1050(mm)	1130*900*980(mm)	1700*1150*1770(mm)
Price	\$4095	\$3995	\$10995

Accessories & Parts for Tire Changer

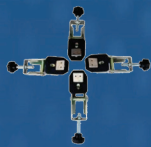

Motorcycle/ATV Rim Clamp Adapter Set **\$299**



Plastic Mounting/Demounting Head **\$50**
(without metal adaptor)

Plastic Mounting/Demounting Head **\$80**
(with metal adaptor)



Metal Mounting/Demounting Head **\$120**

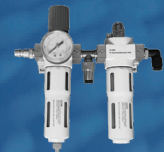

Filter/Regulator/Lubricator **\$135**
1/4" Gauge included



Filter/Regulator/Lubricator **\$95**
1/4" Gauge included



Air Cylinder for Turn Table **\$180**



Tire Changing Lever **\$30**



Plastic Protection Kit for Alloy Rim **\$25 (4pcs)**



Plastic Protection Kit for Mounting/Demounting Metal Head **\$30 (6 sets)**

WHEEL BALANCERS

Wheel Balancers



Model	WB-511	WB-611	WB-514
Design	Manually input for Car/Light Truck	Semi-Automatic for Car/Light Truck	Fully Automatic for Car/Light Truck
Power Supply	110V/1PH/250W	110V/1PH/250W	110V/1PH/250W
Max. Wheel Weight	154Lbs(70Kg)	143Lbs(70Kg)	143Lbs(70Kg)
Rim Diameter	10"-26"	10"-26"	10"-26"
Rim Width	1.5"-20"	1.5"-20"	1.5"-20"
Balancing Accuracy	+/- 1g	+/- 1g	+/- 1g
Measuring Time	6-9s	6-9s	6-9s
Noise Level	<70dB	<70dB	<70dB
Packing Size	900*700*1170mm	980*700*1111mm	980*800*1290mm
N/G Weight	209Lbs/299Lbs	260Lbs/350Lbs	275Lbs/365Lbs
Price	\$1995	\$2395	\$2995

Combo Specials:



TC-412 + WB-511 \$3495
SAVE \$500



TC-512B + WB-514 \$5695
SAVE \$500



TC-412A + WB-611 \$4295
SAVE \$500



TC-612B + WB-514 \$5995
SAVE \$500

NEW MODEL WHEEL BALANCERS

New Model Wheel Balancer



Model	WB-1120	WB-711	WB-1850
Design	Semi-Automatic for Car/Van Wheel	Fully Automatic for Car/Light Truck Wheel	Semi Automatic for Car and Big Truck, Built in wheel lift
Power Supply	110V/1PH/250W	110V/1PH/250W	220V/1PH/550W
Max. Wheel weight	143Lbs(65Kg)	143Lbs(65Kg)	330Lbs(149Kg)
Rim diameter	10"-24"	10"-24"	10"-30" Max. Tire Diameter 33" CarMode/51" Truck
Rim Width	1.5"-20"	1.5"-20"	5.5"-20"
Balancing accuracy	+/- 0.04oz	+/- 0.04oz	1g Car/ 10g Truck
Measuring time	8s	8s	8s
Noise level	<70dB	<70dB	
Packing Size	960*760*1250mm	960*760*1250mm	960*1220*1190"mm
N/G weight	216Lbs/250Lbs	227Lbs/277Lbs	498Lbs/601Lbs
Price	\$2095	\$2695	\$2695

Accessories & Parts for Wheel Balancer



Fe Adhesive Wheel Balancer Weights
1/4 oz x 12-50 pcs/box
\$35 / Set



AW-Zn-Clip-on-Weights
0.25oz-50pcs/0.50oz-50pcs/0.75oz-50pcs/
1.00oz-25pcs/1.25oz-25pcs/1.50oz-25pcs/
1.75oz-25pcs/2.00oz-25pcs
\$110 / Set



AW-Coated-Fe-Clip-on-Wheel-Weights
0.25oz-50pcs/0.50oz-50pcs/
0.75oz-50pcs/1.00oz-25pcs/
1.25oz-25pcs/1.50oz-25pcs/
1.75oz-25pcs/2.00oz-25pcs
\$150 / Set



Quick Clamping Nut with Bowl
40mm - **\$105**
36mm - **\$95**



Wheel weight plier
\$32



Wheel Rim Width Measuring Gauge
\$20



Wheel Cones Set with Truck Flange
\$350 / Set



Truck Cone with Flange Set
For 40mm/36mm Shaft
\$160 / Set



Motorcycle Adapter Set
\$350 / Set



Touchless Motorcycle Adapter Set
\$540 / Set

TWO POST LIFT AND SMALL SCISSOR LIFT

CL-245MP 10,000lbs 2 Post Lift with ETL/CSA Certified Power Pack

- Manual release from two sides and pedal release from one side, self-locking protection device, safe and easy to operate.
- Equip height limit switch to ensure the lifting height safely, prevent the vehicle roof from damaging.
- Minimum height of the lifting pad is 110mm, easily lift and suitable for low profile cars and SUV's.
- Reliable oil cylinder, adopts chrome-plating honed cylinder and piston rod, with Italian seals on hydraulic rams, ensure long service life
- Passed 115% dynamic test and 150% static test



TLT-210AS Launch ETL/ALI Certified 10,000lbs 2 post Lift

- Lift vehicle symmetrically and asymmetrically- Assures maximum service bay efficiency.
- Adjustable Column Height - Provides an extra 6" higher
- Stackable Foot Pads Extensions, with the two 6" tall and two 3" short extensions.
- Single Point Lock Release - Allows technicians to disengage both column locks simultaneously.
- Heavy Duty Arm Restraint System - Oversize rugged steel gears and springs for trouble operation.
- Double Telescoping Screw Pads - Used with or without rubber pads offering 6.5" adjustment

Model #	CL-245MP	TLT210-AS
CI Descriptions	Overhead, 2 post lift	Overhead, 2 post lift
Lifting Capacity	10,000lbs	10,000lbs
Lifting Height	76"(1900mm)	76.4"(1920mm)
Column Height	150"(3810mm)	148.8"(3780mm)
Inside Column Width	101"(2576mm)	110.2"(2800mm)
Drive-Thru Clearance	95"(2414mm)	98.4"(2500mm)
Lifting Speed(S)	≤54s	≤50s
Dropping Speed(S)	≤54s	≤50s
Overall Width	135"(3426mm)	136.6"(3470mm)
Max. Load Per Arm	2750Lbs	2750Lbs
Ceiling Height Required	154" (12.83')	149.5" (12.45')
Narrow Bay Setting		Deduct 5.9"(143mm)
Motor	2HP	2HP
Voltage	220V/Single Phase	220V/Single Phase
Warranty	1 Year	1 Year
Price	\$3195	\$3995



Model	CL-S30H	CL-S30Z
Description	Low-Rise Scissor lift	Mid-Rise Scissor lift
Lifting capacity	2500kg (5500Lb)	3000kg(6600Lb)
Lifting height	25"(635mm)	27.6"(700mm)
Platform height	3.7"(95mm)	4.1"(105mm)
Platform length	55"(1400mm)	57" (1450mm)
Platform width	19.7"(500mm)	18.9" (480mm)
Lifting time	≤25s	≤30s
Dropping time	≤25s	≤30s
Width	74"(1880mm)	67"(1710mm)
Length	79.7"(2024mm)	80.7"(2050mm)
Warranty	1 Year	1 Year
Price	\$2895	\$3695

CL-S30Z Mid-Rise Low Profile Scissor Lift \$3895

- Electro-hydraulic with mid-rise surface mounted, is perfect equipment for tire changing, quick service, etc.
- Low profile platforms, only 105mm high when fully lowered, need less space.
- Pneumatic safety lock is automatically engaged after pressing the up/down button.
- Anti-surge valve prevents the arms from sudden falling in case of broken hydraulic hose for both operator and vehicle's safety.
- Low voltage controls conform to CSA standards

CL-S30H Low Rise Portable Small Scissor Lift \$2895

- Electro-hydraulic with mid-rise surface mounted, is perfect equipment for tire changing, quick service, etc.
- Low profile platforms, only 95mm high when fully lowered, need less space.
- Each platform is the complete steel plate without splicing, to ensure flatness and durability.
- With safety rack in each column, mechanical safety lock is automatically engaged during lifting.

FOUR POST COMMERCIAL LIFT

CL-455 12,000 lbs Commercial Grade Four Post Lift

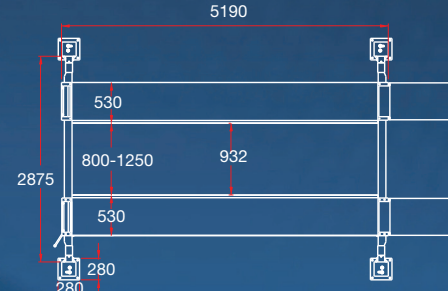
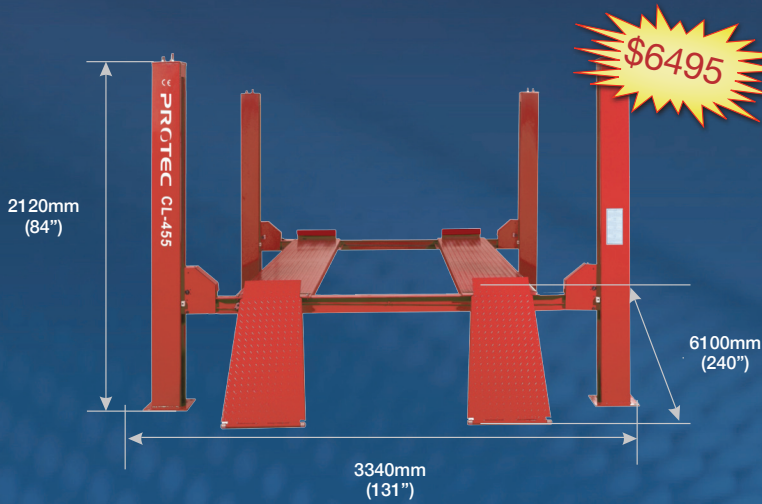

OVERALL DIMENSIONS

SPECIFICATIONS:

Power Supply 220v (1 ph)
Motor Power 3HP



CL-455



Lifting capacity
≤5500kg
(12125 lbs)



Lifting height
≤1700mm
(67")



Platform length
≤5190mm
(204")



Platform height
195mm
(7.7")



Rise time
≤35 S

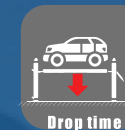

Drop time
≤35 S

CL-455A 12,000lbs Commercial Grade Four Post Alignment Lift

SPECIFICATIONS:

Power Supply 220v (1 ph)
Motor Power 3HP



CL-455A



Lifting capacity
≤5500kg
(12125 lbs)



Lifting height
≤1750mm
(69")



Platform length
≤5190mm
(204")



Platform height
245mm
(9.6")



Rise time
≤35 S

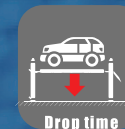

Drop time
≤35 S

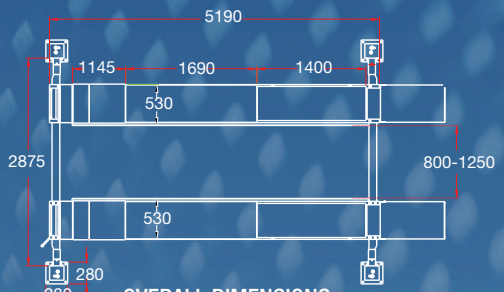
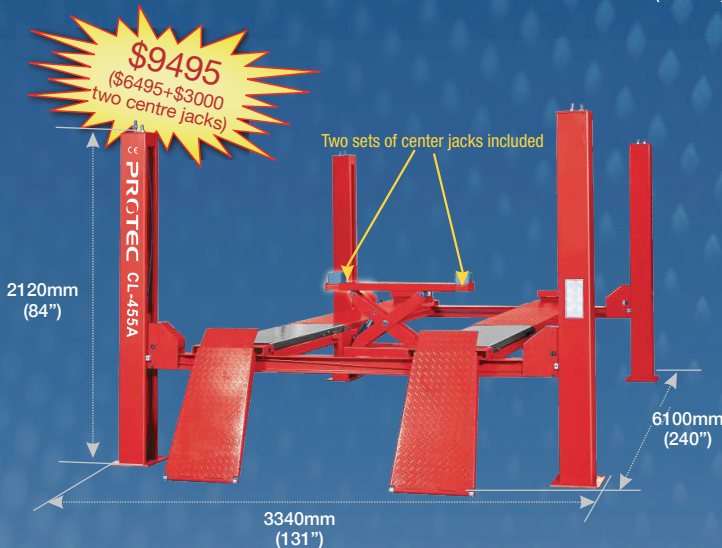

OVERALL DIMENSIONS

Delivery and Installation not included

FOUR WHEEL ALIGNMENT SYSTEM

CL-S55A 12,000lbs Alignment Scissor Lift

Large Platform Scissor Lift for Four Wheel Alignment

Open front design that provides easy access to alignment service and calibration areas.

- 26" Wide runways provide easy drive-on for large vehicles.
- Hydraulic equalization and full support rear member deliver repeatable smooth level lifting.
- Turntables are adjustable and suitable for different automobile.
- The two Centre Jacks are included for wheel alignment.
- Pneumatic safety lock is automatically engaged after pressing the up/down button.
- Anti-surge valve prevents the arms from sudden falling in case of broken hydraulic hose, for both operator and vehicle's safety.
- Each platform is one piece without welding to ensure flatness and durability.
- Low voltage controls conform to CE standards.

\$14995
(\$11995+\$3000
two centre jacks)

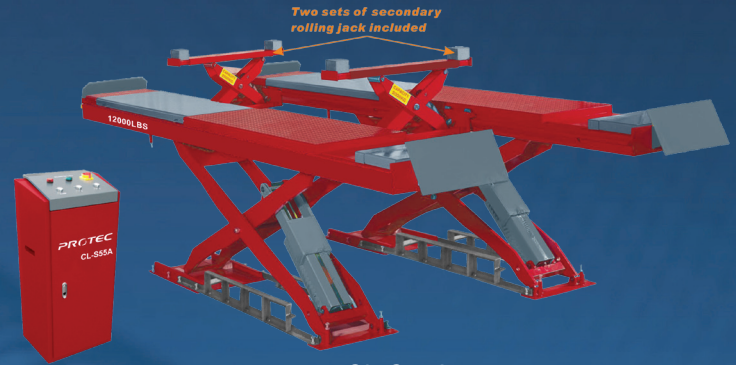

CL-S55A

Model	Machine Body	Lifting Capacity	Lifting Height	Platform Height	Platform Length	Platform Width	Lifting Speed	Dropping Speed	Overall Width	Overall Length
CL-S55A	Main Unit	12000lb	72.8"	15"	197"	26.4"	≤55	≤55	84.3"	216.50"

Ultra 3D+ Wheel Aligner

- 20 degree in-turnplate push rolling-out compensation
- Non-stop at push rolling-out compensation
- 10/20 degree non-stop at caster swing
- Camera bar cruise control to follow lift movement automatically, assure 100% full height range measurement (Ultra 3D+)
- Ultra bright target, minimal sunlight abuse
- Vehicle position auto adaptive
- Simplicity and painless at installation
- 4-step calibration (only needed when change camera)
- Two years warranty and two years free update

\$12995



Ultra 3D
Fixed Height, Fixed Column

\$14995

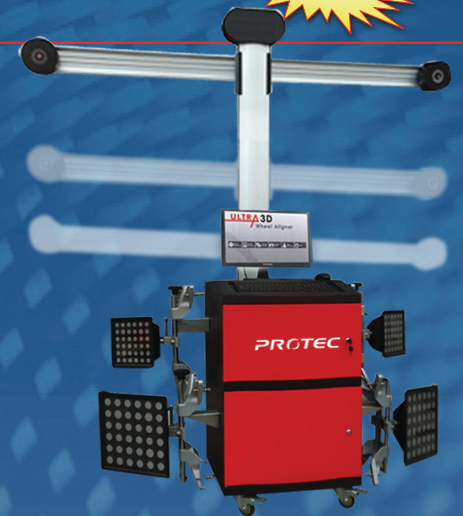

Ultra 3D+
Camera bar move automatically

Declinometer Input



Main Screen



Target Monitoring

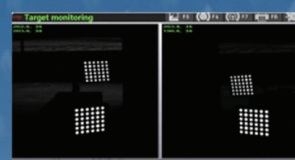

Test Result



3D WHEEL ALIGNMENT

Elite 300

\$15495

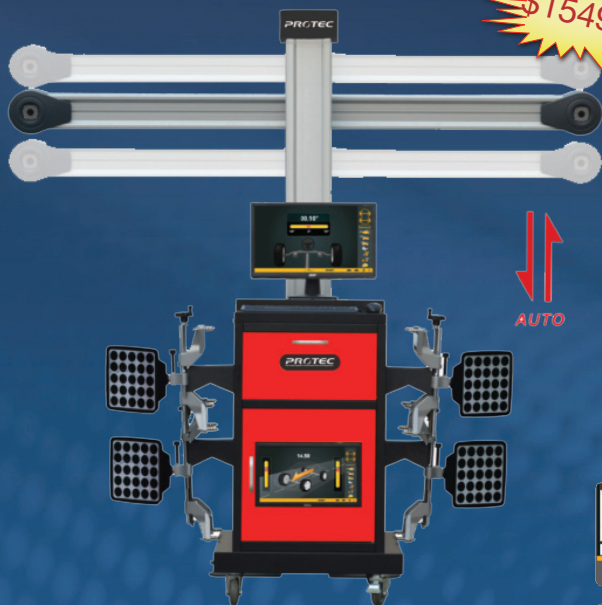

Elite 400

\$15995

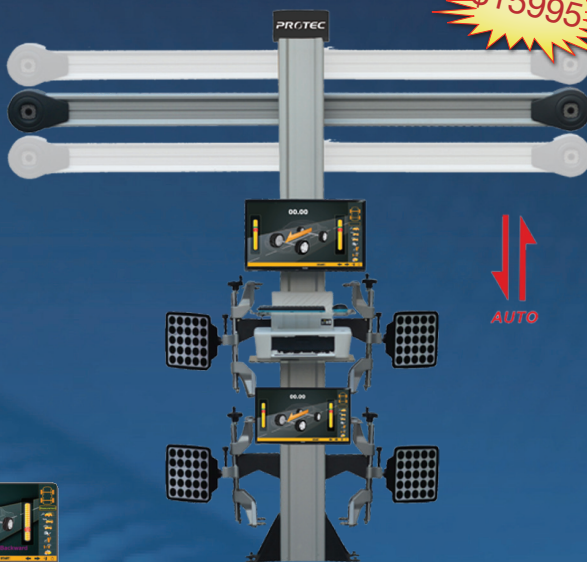

- Intelligent Auto Tracking Function
- Pure Aluminum Alloy Beam and Column
- Optional Dual-display System
- Ergonomic Durable Targets
- Universal Wheel Adaptors
- Over 40 thousand Vehicle Specifications
- Rich Help Videos
- Camera Drive-on Aid
- Multiple Languages
- Vehicle Body Dimension Measurement

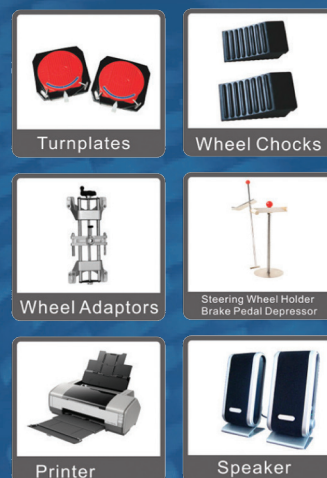
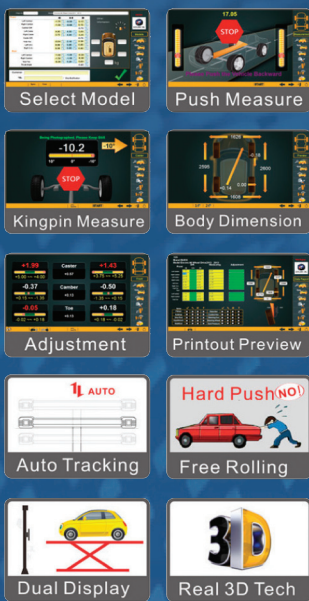

Select vehicle model
Search logo and model
Record specifications



Mount clamps and targets
Use the suitable jaw
Protect with safe straps

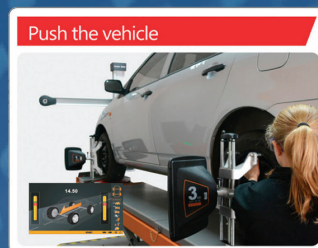

Push the vehicle
Capture the measurement
Preview results at once



Turn the steering wheel
Unlock the turnplates
Remove the wheel bridges
Install the brake pedal depressor



Vehicle adjustment
Camber adjustment
Toe adjustment



Print the results
DIY report available
Do more alignments
Gain more profit

Delivery and Installation not included

FOUR WHEEL ALIGNMENT SYSTEM

Alignment Lift and Alignment Machine Combo Special

Two sets of center jacks included

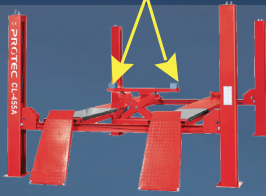

+

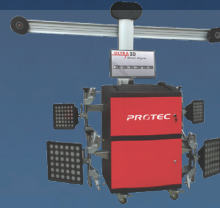

=

\$20,990 (SAVE \$1500)
CL-455A + Ultra 3D

Two sets of secondary rolling jack included

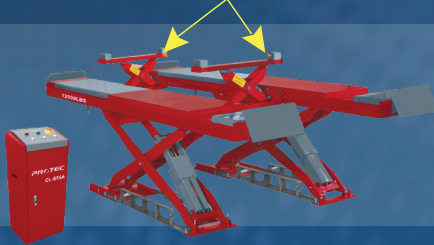

+

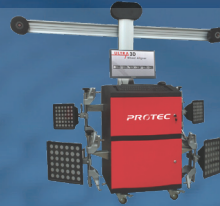

=

\$25,990 (SAVE \$2000)
CL-S55A + Ultra 3D

Two sets of center jacks included

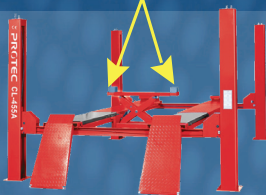

+

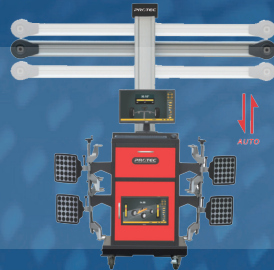

=

\$23,490 (SAVE \$1500)
CL-455A + Elite 300

Two sets of secondary rolling jack included

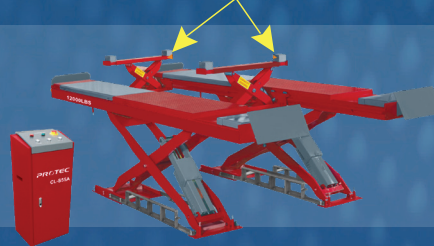

+

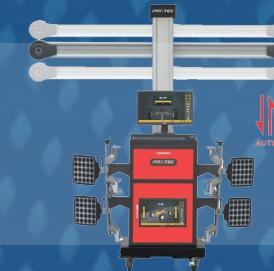

=

\$28,490 (SAVE \$2000)
CL-S55A + Elite 300

Two sets of center jacks included

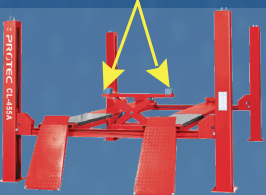

+

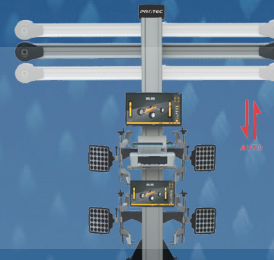

=

\$23,990 (SAVE \$1500)
CL-455A + Elite 400

Two sets of secondary rolling jack included

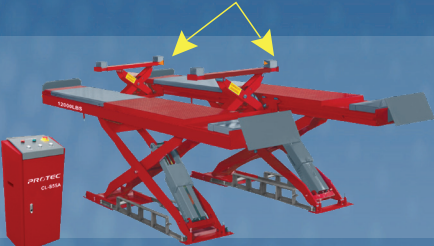

+

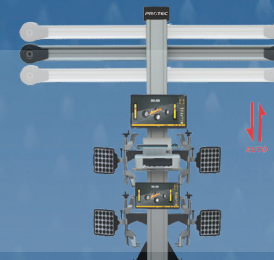

=

\$28,990 (SAVE \$2000)
CL-S55A + Elite 400

SPECIALTY TOOLS

AC-1528
\$260



Coolant Pressure System Tester Set - 19pcs

AC-1528-17
\$25



Radiator Leakage Testing Adaptor BMW-E60,E65,E81,E88,E60,E87

AC-1528-18
\$25



Radiator Leakage Testing Adaptor VW 1.8T, 2.8,BENTLEY

AC-1528-19
\$25



Radiator Leakage Testing Adaptor TOYOTA-RAV4.PREVIEW

AC-1528-20
\$25



Radiator Leakage Testing Adaptor SAAB

AC-1528-21
\$25



Radiator Leakage Testing Adaptor FORD, JAGUAR, OPEL, LAND ROVER, BUICK, BENZ(M-CLASS)

AC-1528-22
\$25



Radiator Leakage Testing Adaptor BMW, MINI, LAND ROVER

AC-19027
\$350



Coolant Pressure Tester + Refill Master Set

AC-19036
\$99

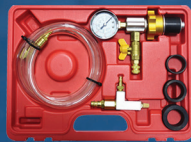

Cooling System Vacuum Purge Refill Kit

AC-19036b
\$95



Coolant Refill Kit

AT-5335
\$280



1/2" Dr - Impact Gun

AV-41107
\$140



AUDI - VW FSI- 2.0L- Timing Kit

AV-41116
\$145



AUDI/VW A4/A6 3.0L 2002 + Camshaft Locking Tool

AV-41322A
\$200



AUDI - 2.0L TFSI Timing Tool Set

AV-4185
\$50



Audi / VW-Timing Locking Tool Set-7pcs

AV-4320
\$115



AUDI / VW - Cam Pulley Puller Set- 6 Stands

AV-4713
\$18

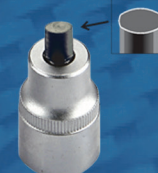

AUDI / VW - Shock Absorber Ram Dismantle Socket

BA-4910
\$105



Wiper Arm Puller Heavy Duty

BA-73322
\$18



Auto Body Trim/Molding Remover 5 Pcs Set

BM-31213a
\$25



BENZ Spark Plug Socket Thin Wall w Magnetic

BS-1025
\$150



Brake Fluid Bleeder/ Extractor-2L

BS-1452A
\$115



Positive & Negative Caliper Wind Back Kit 21 pcs

BS-25014S
\$75

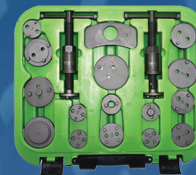

Universal Caliper Service Set 18pcs

BS-25013A
\$10



3 Point-Rear-Brake-Caliper-Adapter

BS-25014
\$110



Universal Caliper Set - 21 pcs

BS-4687
\$160

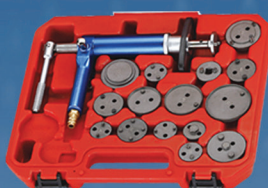

Universal Caliper Service Kit - AIR Tool 16 Pieces

BZ-1415
\$55



BENZ-W163/ML-Class Ball Joint Socket

EE-12113
\$45



Torque Angle Meter

EE-4808
\$28



Cam / Crank Seal Hook Puller-3pcs

SPECIALTY TOOLS

ER-1313
\$200



Fan Clutch Tools Set

FM-16290
\$45



FORD/ MAZDA-
2.0/2.3/2.5L
Timing Tool Set

FM-41102
\$100



MAZDA 3
Front Wheel Bearing
Press Adapter Set

GS-1001A
\$300



FWD Front Wheel
Bearing Tool

GS-14602
\$18



Oxygen-Sensor-Socket

GS-1542
\$48



Bolt / Screw Extractor
Socket Set-6 pcs
3/8" Dr:
2-3-4- 6-8-10 mm

GS-34214A
\$105



Bolt-Nut-Extractor
Socket Set - 11 Pcs -
3/8" Dr: 8-10-11-12-13-14mm
1/2" Dr: 16-17-18-19-21mm

GS-4195
\$40



Fuel & Oil Line
Disconnect Set
Plastic-10pcs

GS-4492
\$500



Universal Hub Bearing
Remover/ Installer

GS-4639
\$70



Bolt / Screw Extractor
Socket Set Stubby
15pcs

HA-19002
\$45



Honda Crank Pulley Holder

OS-1256
\$60



Engine Oil
Pressure Tester

OS-1114
\$25



Oil Filter Socket
14P/65mm
TOYOTA,NISSAN,
HONDA

OS-1021
\$25



Oil Filter Socket
14P/67mm
FORD,MITSUBISHI,
MAZDA,KIA,SUZUKI

OS-1235
\$25



Oil Filter Socket
14P/74mm
BENZ, BMW, AUDI,
VW, HYUNDAI, KIA

OS-1403
\$25



Oil Filter Socket
15P/79mm
MITSUBISHI,HONDA,
NISSAN,TOYOTA,SUZUKI

OS-1515
\$25



Oil Filter Socket
15P/82mm
HYUNDAI, KIA

OS-1521
\$25

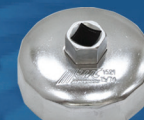

Oil Filter Socket
15P/74mm
VW, AUDI

OS-1522
\$25



Oil Filter Socket
16P/87mm
VOLVO, BMW

OS-4104
\$28



Oil filter Socket
15P/92mm
LAND ROVER,JAGUAR,GM,
OPEL,PORSCHE,FORD

OS-4103
\$25



Oil filter Socket
30P/76mm
LAND-ROVER,JAGUAR

OS-4160A
\$28



Oil filter Socket
15P/90mm
LAND ROVER, KIA,
HYUNDAI

OS-4452
\$25



Oil filter Socket
12P/75.5mm
FORD 2.0TDCI
SMART

OS-4611
\$25



Oil filter Socket
15P/75mm FORD, MAZDA,
VOLVO, LAND-ROVER

OS-4667
\$28



Oil filter Socket
14P/72.5mm TOYOTA

OS-4668
\$25



Oil filter Socket
30P/75mm
FORD, MAZDA

OS-4669
\$25



Oil filter Socket
12P/76mm
PEUGEOT,
CITROEN,RENAULT

OS-4670
\$28



Oil filter Socket
18P/86mm PEUGEOT,
CITROEN, RENAULT

OS-4695
\$28



Oil filter Socket
14P/84mm
BENZ OM642 CDI

OS-4666
\$200



Steel Oil filter
Socket Set-16pcs

SPECIALTY TOOLS

OS-18014
\$20



Engine Oil Cap
Toyota/Lexus
1.8L/2.4L/3.5L

OS-18465
\$15



Engine Oil Cap
Toyota/Lexus
Universal-64mm/14pt

OS-18474
\$23



Engine Oil Cap
Benz Deep
74mm/14pt

OS-18484
\$28

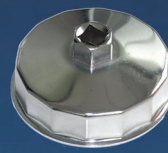

Engine Oil Cap
Benz - Blutec CDI
84.4mm/14pt

OS-18575
\$20



Engine Oil Cap
Ford / Mazda
75mm/15pt

OS-18687
\$22

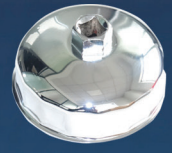

Engine Oil Cap
BMW-86.6mm/16pt

OS-18687A
\$28



Engine Oil Cap
Volvo Deep-86.6mm/16pt

OS-18905
\$50



Oil Filter Socket Set-5pcs

OS-2030
\$45



13mm Oil Drain Plug
Repair Set
Tap + 6's Nut

OS-2031
\$45



15mm Oil Drain Plug
Repair Set
Tap + 6's Nut

OS-2032
\$45



17mm Oil Drain Plug
Repair Set
Tap + 6's Nut

OS-2033
\$50



20mm Oil Drain Plug
Repair Set
Tap + 6's Nut

OS-41544-A
\$65



ATF-Fluid-Refill-Nozzle-Set - 3 pcs

OS-41544-106 BENZ 722.9 \$25
OS-41544-107 AUDI/VW/ CVT \$25
OS-41544-108 AUDI/VW/DSG \$25

OS-41544-B
\$110



ATF-Fluid-Refill-Nozzle-Set
8 pcs

OS-5435
\$130



Universal Refilling Funnel Set
Adaptor + Funnel + Angle Tube
Audi / Benz / Toyota / Chrysler / Honda

PS-3002
\$45

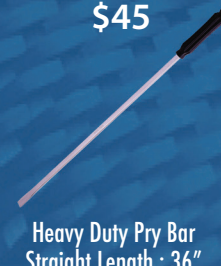

Heavy Duty Pry Bar
Straight Length : 36"

PS-3003
\$45



Heavy Duty Pry Bar
30° Degree Length : 36"

PS-3117
\$45



Mechanic's Pry Bar
4 pcs w/ Capped-End Handle

PS-3207
\$40



Impact Driver Set

PS-3629
\$40



Heavy Duty Pry Bar
Straight Length : 29"

PS-5823
\$25



Adjustable Pry Bar
10"

PS-5824
\$32



Adjustable Pry Bar
15"

RW-1201
\$65

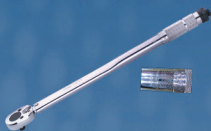

Torque Wrench 1/4" Dr
10-250 in-lb(+/- 4%)

RW-1202
\$80



Torque Wrench 3/8" Dr
10-110 Nm (+/- 4%)

RW-1204
\$105



Torque Wrench 1/2" Dr
30-250 ft-lb(+/- 4%)

RW-1206S
\$100



Pro Wrench Set
15pcs 6 - 21 mm
6,7,8,9,10,11,12,13,14,
15,16,17,18,19,20,21 mm

RW-1605
\$52



Flare Nut Wrench
10pcs-3/8" Dr:
10 - 19 mm

SPECIALTY TOOLS

RW-3013
\$35



Flexible Gear Ratchet
With locking 3/8" Dr
Length: 265mm

RW-3812
\$30



Flexible Gear Ratchet
Without locking 3/8" Dr
Length: 265mm

SE-5811
\$95



High Quality
Plastic Creeper

SE-5921
\$265



3 Shelf Tool Trolley

SE US-1180
\$300



Under Hoist Stand

SS-1037
\$150



Ball Joint Service Set

SS-25119
\$45



19mm Ball Joint Separator

SS-25120A
\$100



Ball Joint Separator Set
3pcs 23 / 28 / 34 mm

SS-25412
\$55



22mm Ball Joint
Separator

TG-1364
\$260



Diesel Compression Tester
0~1000 psi

TG-1520
\$100



Exhaust Back Pressure Gauge Set
Oxygen Sensor Adapters include
M12 and M18 threads

TG-19022
\$95



Compression Test Kit
M10x1.0/M12 x 1.25/M14 x 1.25
M18x 1.5/M16 x 1.5 - Ford Triton

TG-4208
\$165



Cylinder Leakage Tester
w/ M10, 12, 14, 18 Adaptor

TG-4250
\$195



Transmission Pressure Gauge
Dual Gauge:
0 - 100 psi / 0 - 500 psi

TG-4251
\$185



Power Steering System
Pressure Gauge

TN-2120
\$30



Clutch Center Alignment
Tool Set - Universal

TW-1911
\$35



Wheel Weight Tool

TW-3523
\$18



Tire Valve
Screwdriver - 25Ncm

TW-3922
\$18



Tire Seal Repair Kit
Heavy Duty Tire Plug Tool
Close Eye

TW-3923
\$18



Tire Seal Repair Kit
Heavy Duty Tire Plug Tool
Needle

TW-5328
\$25



Digital Tire Tread Depth Gauge
0 - 25 mm / 1"

TW-5611
\$28



Tire Pressure Gauge
0-160 psi: Accuracy +/- 1.5 psi

VO-14309
\$275

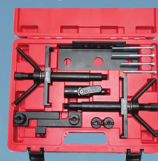

VOLVO Timing Kit

PROTEC

P: 1844-PROTEC9 (1844-776-8329)
or 905-569-8878

For more information, please visit our website:
www.protecequipment.ca

