

**AC-200-dual  
USER MANUAL**

## **Congratulations on the purchase of the AC-200-dual Refrigerant Processor**

This is a very good investment you have made for your workshop. This system will help your technicians in achieving their best capability in diagnosing and rectifying air-conditioning issues, thus increasing productivity and profitability for your business. This system can be customized to suit each individual workshop needs. Our company would like to work with you as partners in your business to help you achieve maximum return on your investment, so please do not hesitate to contact us or our distributors, if we can be of any further assistance in relation to this equipment use and maintenance, or any air-conditioning related issues. We are always here to help you in achieving higher productivity.

AC-200-dual is an ideal option for workshops that have requirements of handling both R-134a and HFO-1234yf refrigerants. The loss of refrigerant is minimized to less than 50 gram at shifting from one refrigerant to another, and deep internal evacuation ensures zero cross contamination between two refrigerants. The machine is equipped with 2 refrigerant tanks, which saves the operators' time of replacing tanks.

The unique design has facilitated quick load cell unlock, easy and economic maintenance (even though DIY maintenance is facilitated by our machine design, it is still highly recommended to leave maintenance job to specialized technicians.), self troubleshooting and convenient USB upgrade etc..

### **General safety**

- The storage cylinder in this unit contains liquid refrigerant. Overfilling of the cylinder can cause violent explosion. Do not disable the overfill safety feature. Always keep the cylinder on the load cell platform whenever operating the machine.
- The operator must carefully read the instruction manual before any operation is performed. Incorrect operations could cause serious consequences, such as, improper A/C service, damage to automotive A/C system or damage to equipment.
- Only use cylinders which are recommended by the manufacturer and supplied with this equipment.
- Avoid inhalation of refrigerant or oil vapor/mist, read material safety instructions on refrigerant and oil package.
- Switch off and disconnect power cable from main supply before removing any cover or servicing the equipment, to avoid electric shock which can be very dangerous or fatal.
- Never use compressed air for leak testing the unit or vehicle A/C system!
- Wear safety goggles and gloves, to protect eyes and skin from contact with refrigerant. Coming in contact with liquid refrigerant can cause frostbite and blindness. If accidental contact is made with liquid refrigerant, wash effected area with plenty of fresh water and contact a doctor.
- Avoid using extension power cable with copper core diameter less than 1.5mm<sup>2</sup>.
- Keep gasoline or other flammable substances away from the equipment.
- Always operate unit in a well-ventilated area and away from artificial heat

## Index

SPECIFICATIONS-----	2
FUNCTION TABLE-----	3
PART DESCRIPTION-----	4
OPERATION PREPARATIONS-----	5
EQUIPMENT CONNECTION(Recovery/vacuum/oil injection/charge/Tank fill/auto mode)-----	7
RECOVERY-----	8
VACUUM-----	8
OIL INJECTION-----	9
CHARGE-----	9
TANK FILL-----	9
AUTO. MODE-----	10
SYSTEM SETTING-----	10
UPDATE-----	11
SERVICE REMINDING-----	12
MAIN TROUBLESHOOTING-----	13

**Specifications:**

- Dimension: Package 710\*660\*1190mm; Unpacked machine 610\*595\*1075mm<sup>3</sup>
- Input power: AC220V±10%~50/60Hz, or AC110V±10%~60Hz
- Pre-ventilation: the machine makes 30 seconds ventilation, before it is powered on.
- Compressor power: 3/8HP
- Average gas state refrigerant recovery speed (through charge/suction port): 0.25Kg/min.
- Hand valves free.
- Recovery rate: 96%.
- Vacuum pump capacity: 120L/min, non-sparkle.
- Accuracy of gas cylinder load cell: ±10g
- Capacity of dual gas cylinders (one for R-134a, one for HFO-1234yf): 10KG
- New oil bottle capacity: 250ml
- Used oil bottle capacity: 400ml
- Dual condensers and cooling fans, one for R-134a, one for HFO-1234yf
- Max. Pressure: 20bar
- Charge speed: 2Kg/Min(max.)
- LCD display: 4.3-inch,TFT full color
- High pressure gauge range: -1bar~40bar
- Low pressure gauge range: -1bar~22bar
- A/C database included, update through USB port.
- Automatic service reminding. The equipment provides 600 operations totally (each recovery or vacuum counts for one operation, and automatic mode counts for 2 operations) between regular maintenance, When 600 operations have been made the machine automatically reminds to call distributor for service.

**Function Table**

<b>Main function</b>	Recovery	Recovers and purifies refrigerant from automotive A/C to equipment tank.
	Vacuum	Evacuates air and moisture from the A/C system.
	Oil injection	Inject refrigeration oil to automotive A/C system. Can inject oil by setting volume manually, or automatically.
	Charge	Charge refrigerant from equipment gas cylinder to automotive A/C system
	Tank fill	Transfer liquid refrigerant from an external refrigerant storage cylinder to equipment cylinder.
	Auto. mode	Performs the selected functions in a fully automatic sequence. The machine will stop automatically once all the selected functions have been completed
<b>Sys. setting</b>	Language	Select operation language.
	Calibration	Calibration refrigerant gas cylinder load cells.
	Database	Enter automotive A/C database
	Unit set	Select metric or imperial units
	Empty container weight set	Set empty refrigerant gas cylinder.
	Component test	Test work status of solenoids, vacuum pump and compressor.

### Equipment description

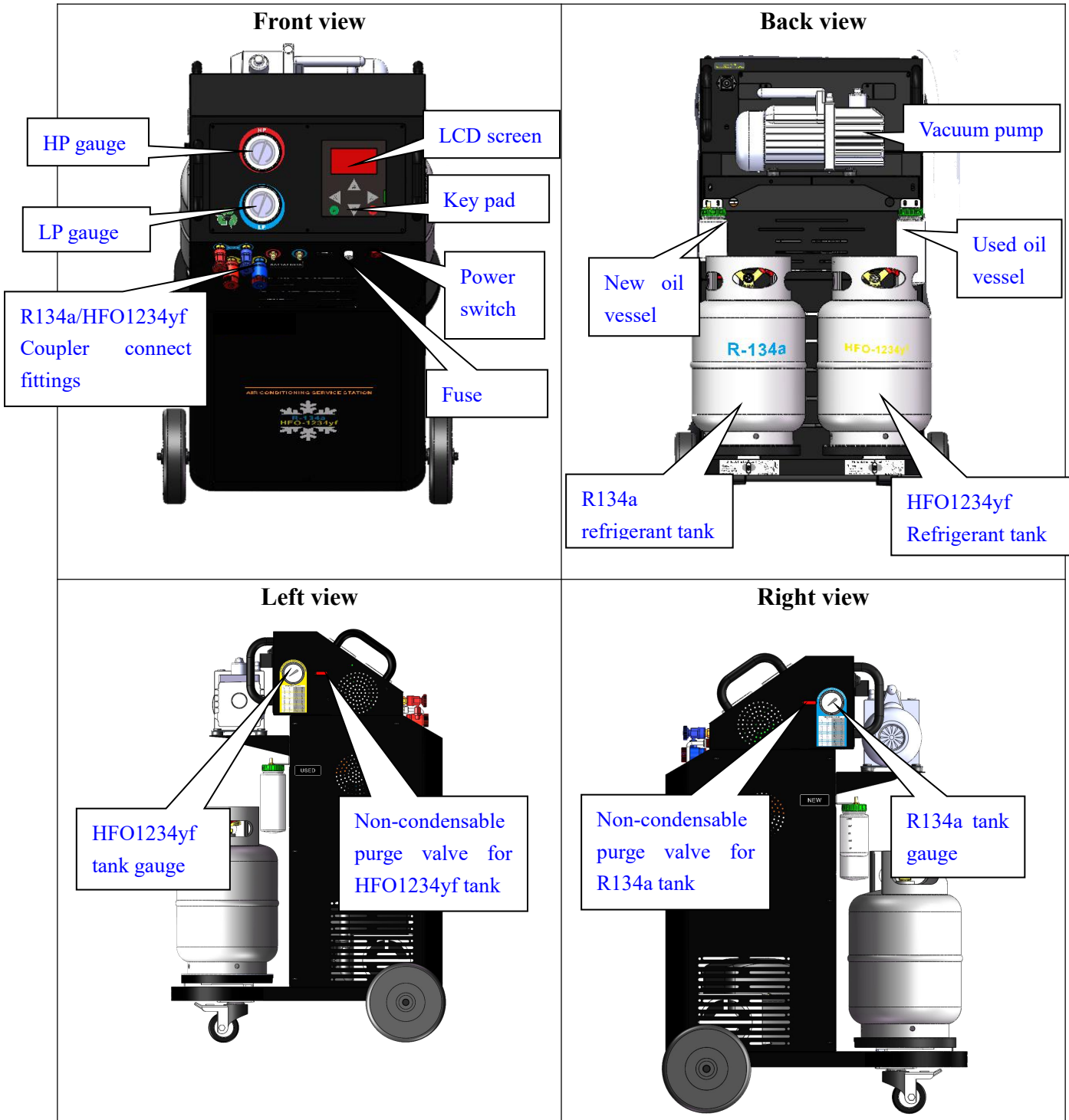

## OPERATION PREPARATIONS

### ■ Unlock load cells.

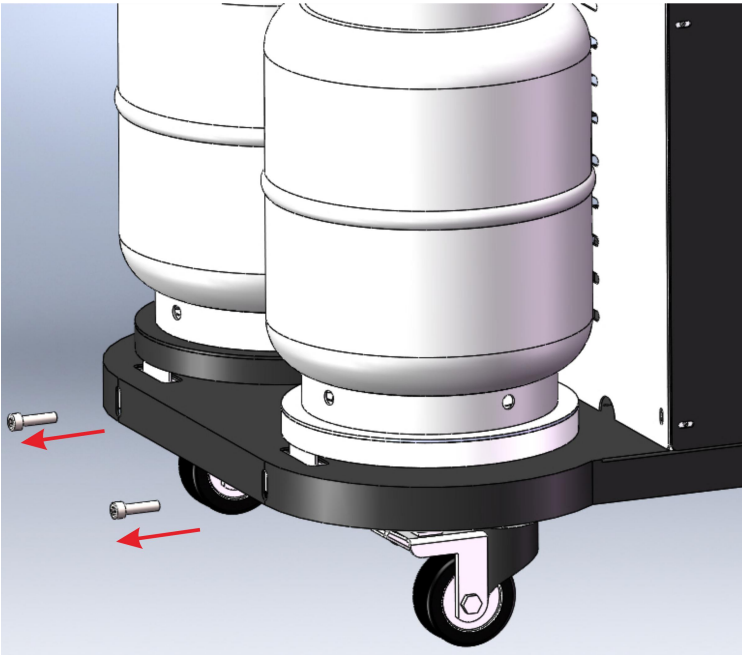

Remove the two lock bolts, to release load cells of the two tanks, and to make them ready to work.

#### **Warning:**

- 1. Failure to remove the load cell lock bolts may cause wrong refrigerant processing amount.**
- 2. When you need transport the machine, please screw those bolts on.**

### ■ Fill equipment with refrigerant (New equipment is empty, you need to fill the equipment with refrigerant and refrigeration oil)

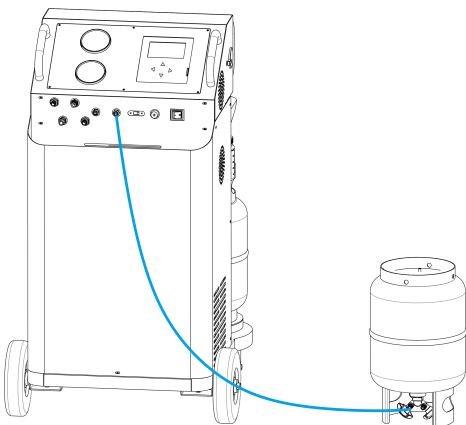

Through tank fittings, connect either HP or LP hose with external refrigerant R134a or HFO-1234yf, and turn on the machine, select “Tank fill” function, set tank fill amount to fill R134a or HFO-1234yf tank with refrigerant.

It is recommended to maintain refrigerant level of both tanks at 4-6kg.

**Non-condensable purge**

It is recommended to purge the air in equipment tanks every day before turning on the machine. At left and right sides of machine, non-condensable purge manual valves and pressure-temperature chart can be found. Turn the valve to purge the non-condensables, strictly abiding by the pressure-temperature chart sticker.

**Select refrigerant**

Each time the machine is turned on, it reminds to select refrigerant type. If the refrigerant type selected is different from the refrigerant handled at previous operation, the machine automatically recovers refrigerant inside machine pipelines, and makes extremely deep internal evacuation, and then shifts to the interface of the selected refrigerant. This process may take 5 minutes or more.

**Notes:**

- 1. Be sure you select same refrigerant type as what the vehicle contains, or serious contamination in equipment tanks will be caused.***
- 2. Anytime you desire to shift from the refrigerant which machine currently handles to another, turn the machine off and turn it on again, and then select refrigerant type.***



**Equipment Connection (For recovery/vacuum/oil injection/charge/Auto. Mode)**

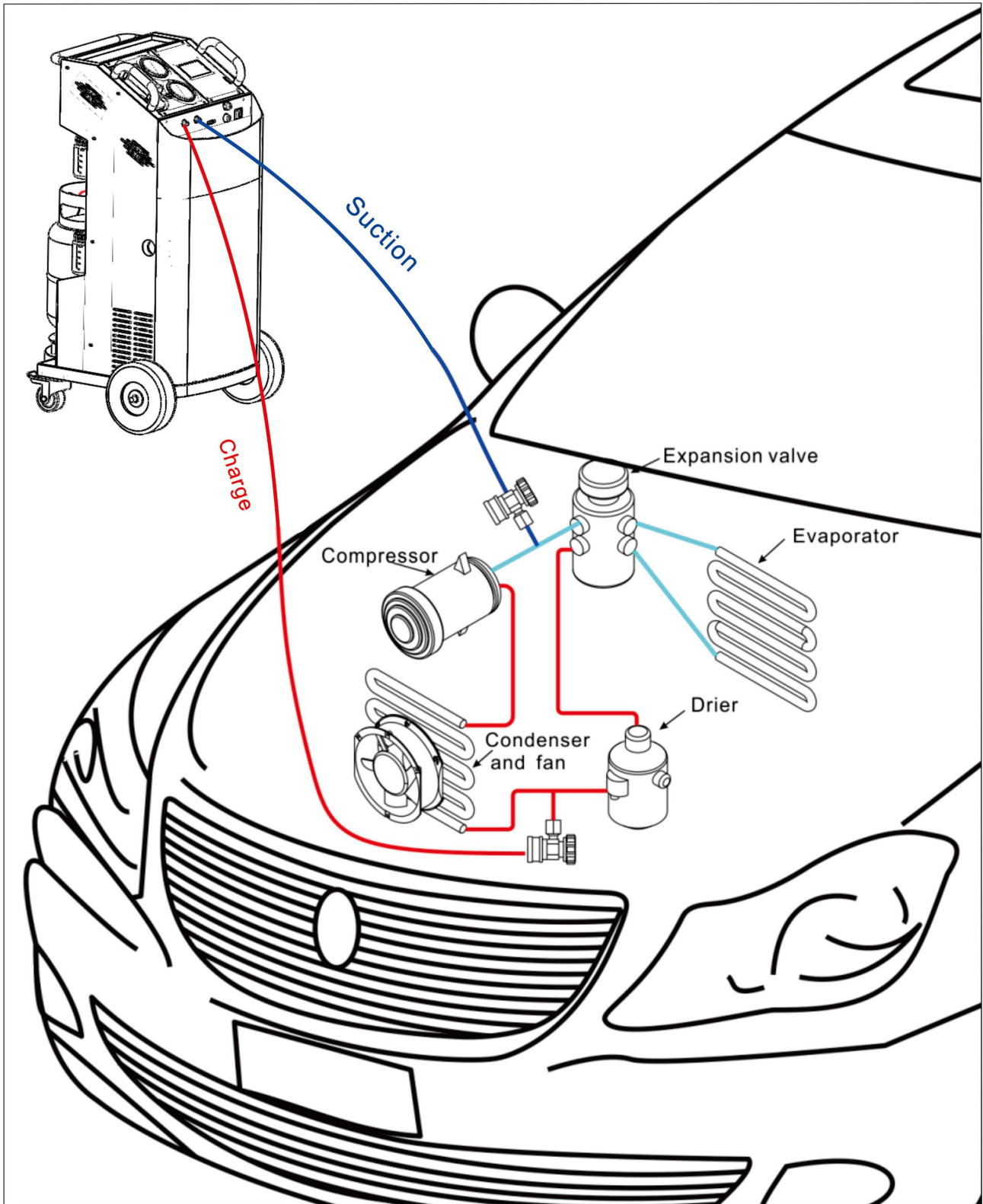

**Warning:** Except the situations clearly stated in the manual, during all equipment operations, please maintain the vehicle engine and A/C off, otherwise unexpected damages may be caused.

## Recovery

Empty used oil vessel before the recovery function is started.

Select “Recovery” function icon and press ENTER to start the process.

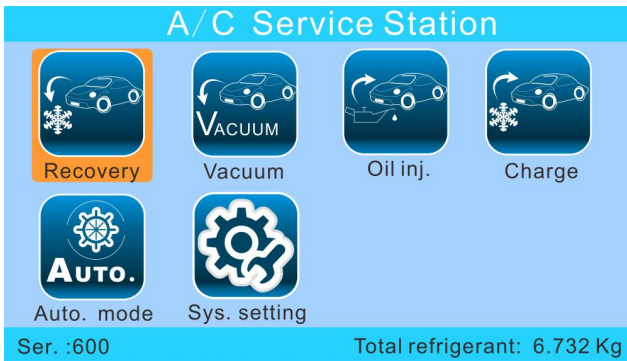

The recovery process recovers the refrigerant from vehicle A/C system, until vacuum degree is achieved in the vehicle A/C system. Moisture, oil and foreign particles are separated from the refrigerant before it is stored in the internal refrigerant cylinder. The machine should be left connected on the vehicle for a minimum time of 3 minutes (longer in cold climates) for any pressure increase test. If after 3 minutes (or longer if possible) there is no pressure increase, the recovery can be acknowledged completed. If a pressure increase is detected recovery should be processed again.

## Vacuum

Select “Vacuum” icon and press ENTER to start the process.

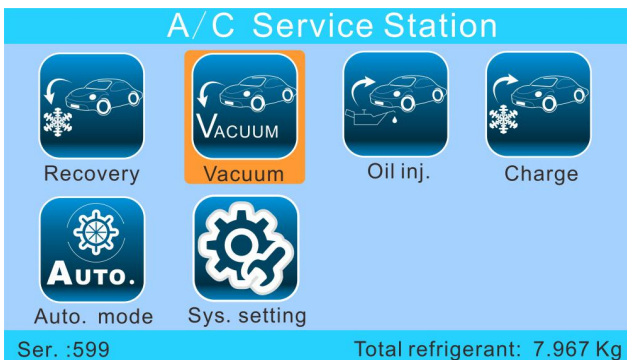

The Vacuum process evacuates system, and makes system ready for oil injection and refrigerant charge. Although it is up to users to determine vacuum time, a longer vacuum process is recommended.

## Oil injection

When A/C system in deep vacuum state, select “Oil inj.” icon and press ENTER to start the process.

Oil enters A/C system through high side service hose.

You can choose “hose flush” to flush and discharge oil remaining in machine internal pipelines and service hoses, to avoid cross contamination of different oils which may cause damage to A/C system. ***It is a MUST to select “hose flush” when you inject POE or any other oil to hybrid or electric vehicles, with PAG oil may remain in machine or service hoses because of previous operations.***

You can determine oil injection volume by setting amount or by manual injection. Manual oil injection is effected by pressing right arrow key on control panel. Please be aware that there is no oil load cell equipped in the machine (the oil injection volume is calculated by injection time), thus the oil volume injected may vary from the amount preset.

## Charge

Select “charge” icon and press ENTER to start the process.

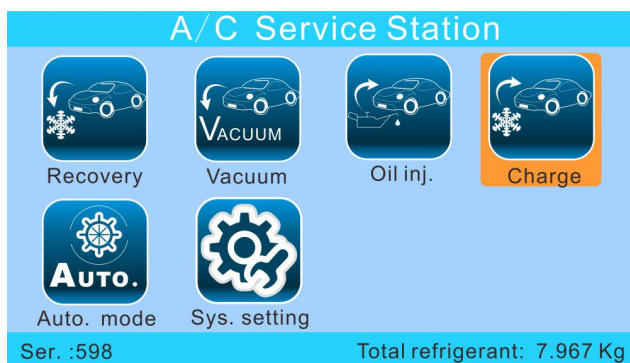

You can manually set charge amount with volume, or select “Charge by database” to set charge amount by car make and model.

You can choose to charge through high side, low side or both sides.

After charge and A/C performance is checked with engine and A/C ON. “Hose purge” option helps charge the refrigerant in service hoses into vehicle A/C system, to ensure better charge precision.

## Tank fill

Select **Tank fill** to fill or add refrigerant into machine storage cylinder. It is recommended to maintain 4-6 kg refrigerant in the machine internal cylinder at all time, to guarantee better charging and flushing operations. During the refrigerant cylinder filling process the machine will display to the technician to **close hand valve on the external cylinder**, the machine will then recover the rest of refrigerant left in the transfer service hose and internal pipelines.

The minimum tank fill set value is 0.5kg.

The maximum tank fill set value is the calculation result of 8kg (80% of tank allowable maximum weight) minus amount of refrigerant the tank contains ( For example, if there is 2kg refrigerant in the equipment tank, the maximum tank set value is 6kg).

## Auto. mode

Empty used oil vessel before the process.

You can select “Auto.mode” to do full cycle of recovery, vacuum, oil injection and charge.

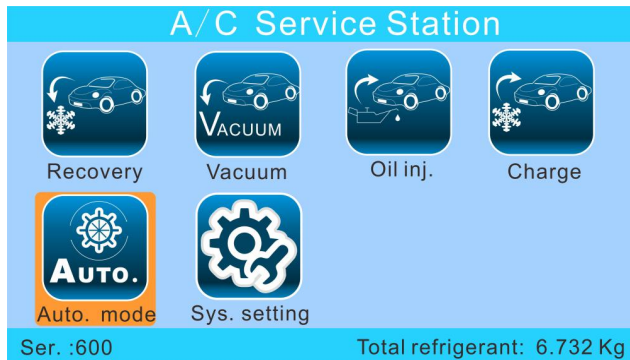

In auto. Mode, the machine makes recovery, vacuum, oil injection and refrigerant charge in sequence automatically, with data preset by users.

## System setting

Select “system setting” icon and input PW 111111 (left and right arrow to move cursor, up and down arrow to increase/decrease number) to enter system setting menu. In system setting, “Language”, “Calibration”, “Database”, “Unit set”, “Empty container weight set” and “Component test” can be inquired or reconfigured.

**Language:** Can change operation system language.

**Calibration:** It is suggested to have only professional technicians to do calibration of load cells. The load cell calibration is very simple and fast, with just one step, 1kg weight calibration step.

*Warning: Misoperation in calibration could bring about serious consequences to equipment or vehicle A/C system.*

**Database:** Users can access database of refrigerant/oil volume of different car makes and models.

**Unit set:** To set metric or American imperial unit. The two numbers displayed in the bottom part of the interface are values of two tank load cells, for load cell diagnosis purpose.

**Empty container weight set:** The total load cell reading equals the sum of empty container weight and net refrigerant content value. Thus, increase/decrease empty container weight, can correspondingly decrease/increase refrigerant value displayed in the main operation interface.

**Component test:** Users can activate/dis-activate different electronic component of the machine. This is for quick and easy diagnosis for troubleshooting.

**UPDATE**

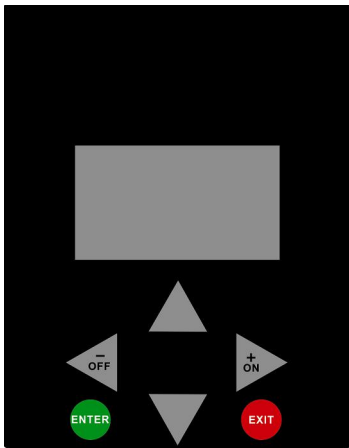

Pressing left and right keys, turn on the machine.

The machine displays the following message.

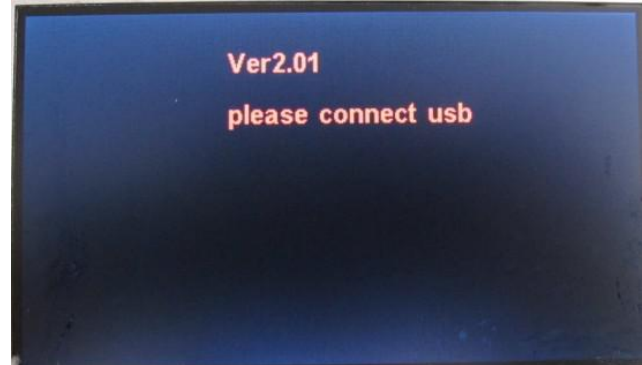

Connect the machine with PC through USB port. In PC, run USBload.exe, the PC displays the following message:

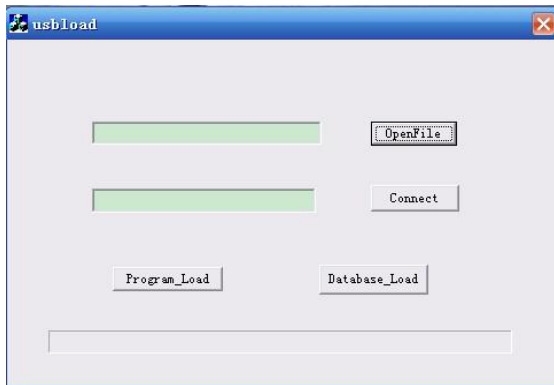

Click "OpenFile" to select update to update, e.g. file "AC200 DUAL\_V2.01" (for main program update) or "Database\_V2.02" (for database update). Then click "Connect" the PC displays the following message

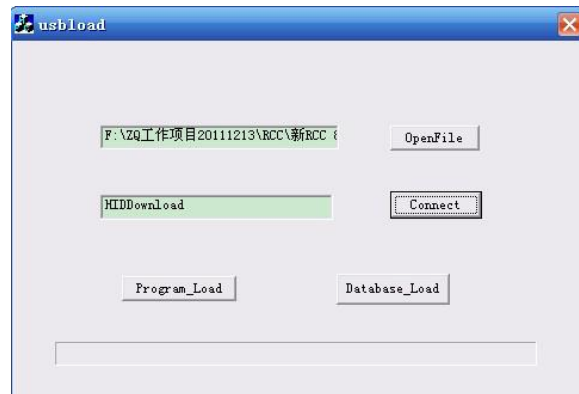

Click "Program\_load" for main program update, or click "Database\_load" for database update, the machine displays the following:

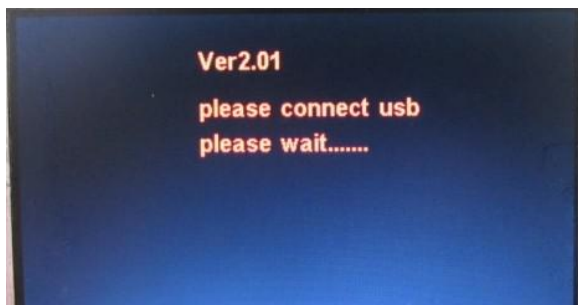

In about 1 minute, the machine displays:

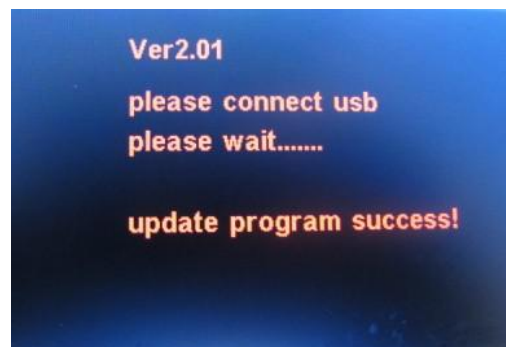

Turn off the machine and turn it on again, the machine will run the updated software.

### Service reminding

The machine permits totally 600 operations (every recovery and vacuum counts for one operation) before regular maintenance is required. The remaining operations before next maintenance is displayed in the left-beneath part of each operation interface.

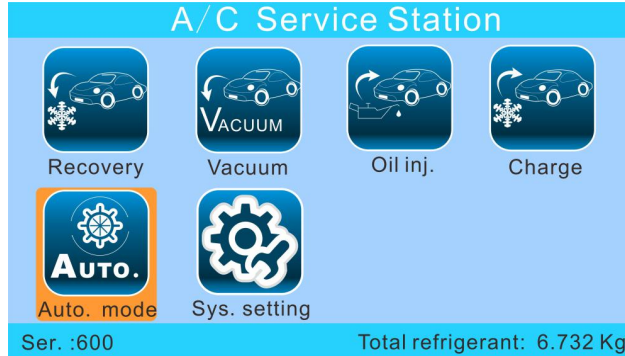

Upon 480 operations having been made, the machine displays the following message, and users can continue using the equipment meanwhile make distributor appointment.



Upon 600 operations having been made, the machine will display the following message while the machine stops working. Service has to be made to reset service interval time again.

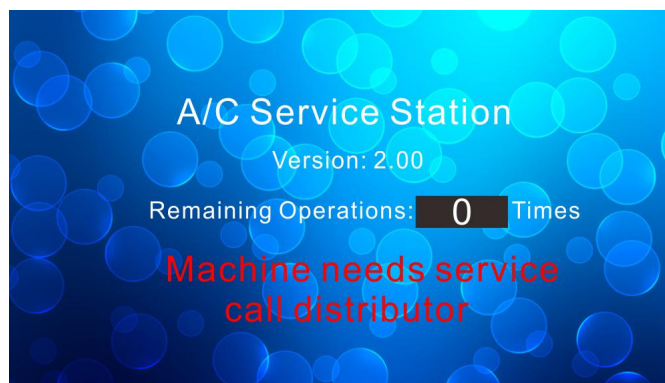

## Main troubleshooting

Malfunction	Reasons	Solution
Low vacuum degree	<ol style="list-style-type: none"> <li>1. Insufficient vacuum pump oil.</li> <li>2. Pump oil emulsion, dirty</li> <li>3. Pump oil inlet plugged.</li> <li>4. Leakage in pump connection.</li> <li>5. Components worn out.</li> </ol>	<ol style="list-style-type: none"> <li>1. Add oil to central line</li> <li>2. Put new oil</li> <li>3. Clean oil inlet.</li> <li>4. Check connection</li> <li>5. Maintain the machine, especially o-ring, washer and other sealing parts.</li> </ol>
Vacuum pump inject oil.	<ol style="list-style-type: none"> <li>1. Excessive oil volume.</li> <li>2. Entrance pressure too high.</li> </ol>	<ol style="list-style-type: none"> <li>1. Discharge some oil to proper level</li> <li>2. Run Recovery function first.</li> </ol>
No display	<ol style="list-style-type: none"> <li>1. Fused (in Power cable connection box, or PCA)</li> <li>2. PCA burnt.</li> <li>3. Power cable loosened.</li> <li>4. LCD not work</li> </ol>	<ol style="list-style-type: none"> <li>1. Change fuses.</li> <li>2. Change PCA.</li> <li>3. Connect power cable reliably.</li> <li>4. Change LCD.</li> </ol>
Recovery does not stop	<ol style="list-style-type: none"> <li>1. Leakage in automotive A/C or equipment pipeline.</li> <li>2. Compressor not work</li> <li>3. Pressure sensor does not work</li> </ol> <p><b>Remarks: In winter, it is normal that recovery takes longer time.</b></p>	<ol style="list-style-type: none"> <li>1. Make leakage test. Machine leakage test with referenc to service manual.</li> <li>2. Change compressor.</li> <li>3. Fasten pressure sensor connection to PCA, or change the pressure sensor.</li> </ol>
No change in recovery volume	<ol style="list-style-type: none"> <li>1. No refrigerant in A/C.</li> <li>2. Support screw of gas cylinder load cell not loosened.</li> <li>3. Gas cylinder load cell not work or PCA failure</li> </ol>	<ol style="list-style-type: none"> <li>1. Stop recovery.</li> <li>2. Unsrew the protection screw, as chapter "Operation preparations".</li> <li>3. Calibrate gas cylinder load cell, or change the load cell, or change PCA.</li> </ol>
While auto A/C has refrigerant, equipment displays alarm 005	Low pressure switch plug disconnected from PCA socket.	Fasten low pressure switch plug.
High pressure alarm 004 but gas cylinder gauge does not show excessive pressure value	<ol style="list-style-type: none"> <li>1. High pressure switch plug disconnected from PCA socket.</li> <li>2. Pipeline connecting compressor exit blocked.</li> </ol>	<ol style="list-style-type: none"> <li>1. Fasten high pressure switch plug.</li> <li>2. Inspect the hoses and connections between compressor exit and tank blue hand vale.</li> </ol>
No charge or slow charge.	<ol style="list-style-type: none"> <li>1. Insufficient refrigerant in equipment</li> <li>2. Charge line problem.</li> </ol>	<ol style="list-style-type: none"> <li>1. Fill equipment tank with more refrigerant.</li> <li>2. Check charge line, including tank red valve, tank red hose, solenoid #5, solenoid #9 (high side), solenoid #11 (long side), service hoses and HP/LP quick couplers.</li> </ol>

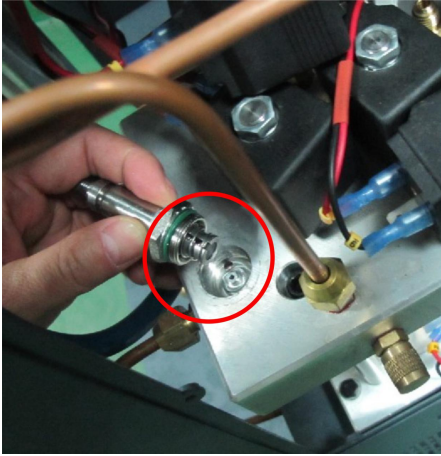
<p>During recovery, vacuum pump is pressurized. After period too much oil in vacuum pump</p>	<p>The contact between solenoid valve #8 and valve base is not well sealed.</p>	<p>Remove solenoid #8 from valve base, clean the solenoid valve and valve base.</p>
 <p>During vacuum, there is suction in old oil bottle.</p>	<p>The contact between solenoid valve #2 and valve base is not well sealed.</p>	 <p>Remove solenoid #2 from valve base, clean the solenoid valve and valve base.</p>

**Remarks: Regular maintenance by specialized technicians is highly recommended.**